



Spoločnosť: \_\_\_\_\_ Telefón: \_\_\_\_\_

Meno: \_\_\_\_\_ Email: \_\_\_\_\_

Adresa: \_\_\_\_\_ Číslo stroja: \_\_\_\_\_

Poloha:  horizontálna   vertikálna   priečna

počet ks: \_\_\_\_\_

Lmax: \_\_\_\_\_ mm

Lmin: \_\_\_\_\_ mm

A: \_\_\_\_\_ mm

B: \_\_\_\_\_ mm

C: \_\_\_\_\_ mm

D: \_\_\_\_\_ mm

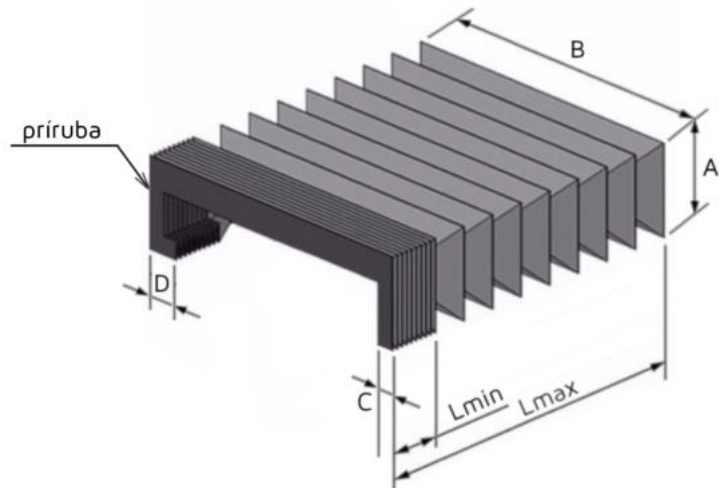

Vyberte tvar krycieho vaku:



Konca vaku: Plastové príruby  Kovové príruby  Suchý zips  iné: \_\_\_\_\_

Typ pracoviska: \_\_\_\_\_, Teplota: \_\_\_\_\_ °C Oceľové špony: \_\_\_\_\_

Chladiaca kvapalina: \_\_\_\_\_, Chemická odolnosť proti: \_\_\_\_\_

Ďalšie požiadavky: \_\_\_\_\_

Prevedenie s krycimi lamelami: \_\_\_\_\_



nevýklopné



výklopné

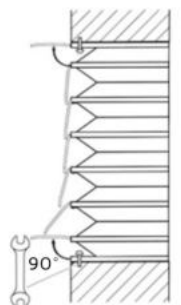

Spoločnosť: \_\_\_\_\_

Telefón: \_\_\_\_\_

Meno: \_\_\_\_\_

Email: \_\_\_\_\_

Adresa: \_\_\_\_\_

Číslo stroja: \_\_\_\_\_

Poloha:  horizontálna

 vertikálna

 priečna

počet ks: \_\_\_\_\_

tvár číslo: \_\_\_\_\_

Lmax: \_\_\_\_\_ mm

Lmin: \_\_\_\_\_ mm

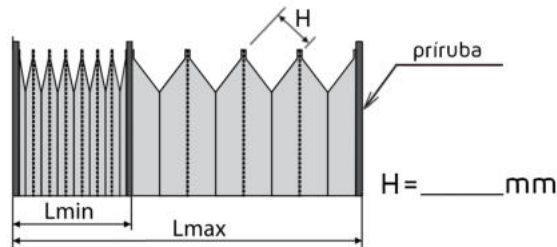

A: \_\_\_\_\_ mm

B: \_\_\_\_\_ mm

C: \_\_\_\_\_ mm

D: \_\_\_\_\_ mm

E: \_\_\_\_\_ mm

G: \_\_\_\_\_ mm

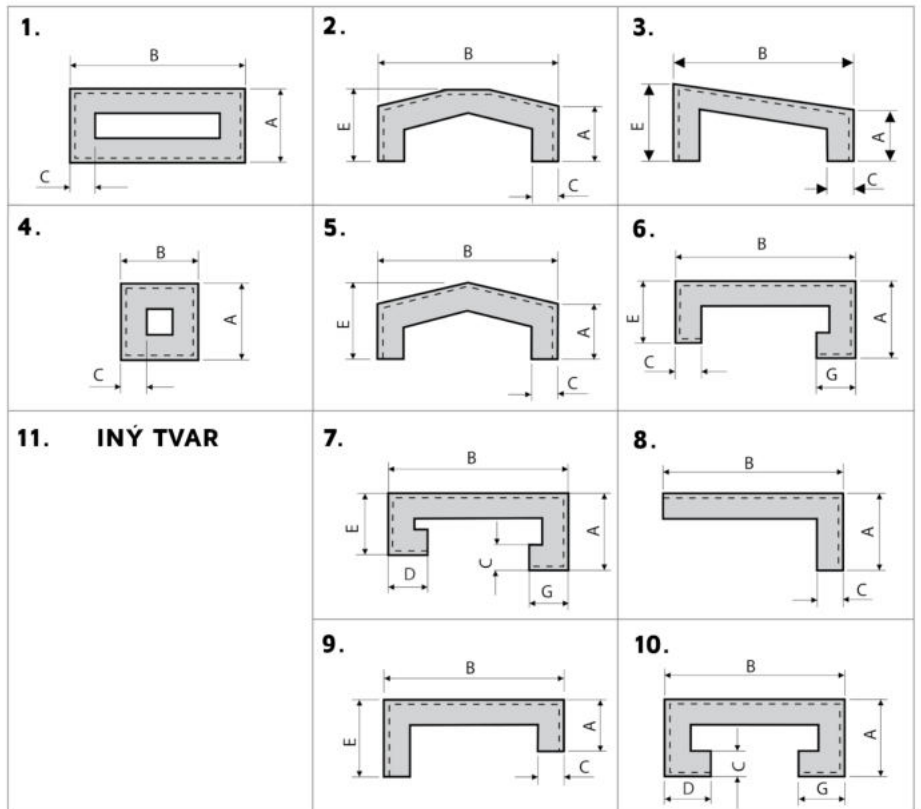

Konca vaku: Plastové príruby  Kovové príruby  Suchý zips  iné: \_\_\_\_\_

Typ pracoviska: \_\_\_\_\_, Teplota: \_\_\_\_\_ °C Ocelové špony: \_\_\_\_\_

Chladiaca kvapalina: \_\_\_\_\_, Chemická odolnosť proti: \_\_\_\_\_

Ďalšie požiadavky: \_\_\_\_\_

Prevedenie s krycimi lamelami: \_\_\_\_\_

nevýklopné

výklopné

